

AVOVA

Sperber-Fix 61 USER MANUAL

- 61cm-105cm
- 3 months-4 years
- ≤20 kg
- UNECE regulation no. R129



GB

Made in Germany

5110001 22/12

1 PRODUCT OVERVIEW

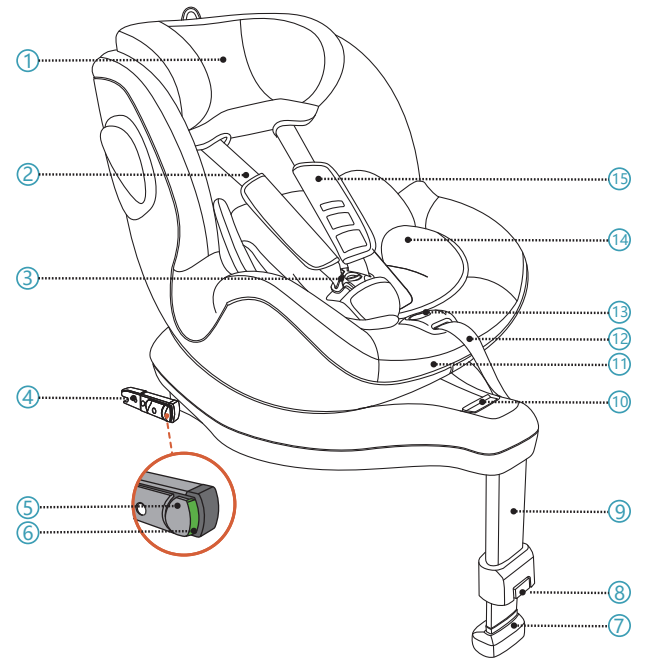

- | | |
|----------------------------|-------------------------------|
| 1. Headrest | 7. Support Leg Indicator |
| 2. 5-point Harness | 8. Support Leg Release Button |
| 3. 5-point Harness Buckle | 9. Support Leg |
| 4. ISOFIX Connector | 10. Rotation Release Handle |
| 5. ISOFIX Locking Button | 11. Recline Adjustment Handle |
| 6. ISOFIX Indicator Button | 12. 5-point Harness Adjuster |

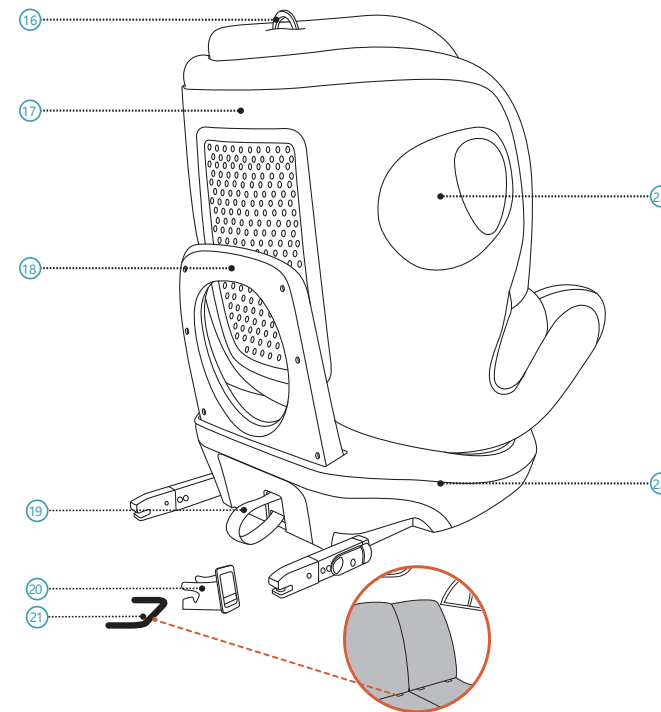

- | | |
|-------------------------------|---|
| 13. Harness Adjustment Button | 19. ISOFIX Release Loop |
| 14. Young Child Insert | 20. ISOFIX Insertion Guide |
| 15. Chest Pad | 21. ISOFIX Anchoring Point (Automobile) |
| 16. Headrest Adjustment Ring | 22. Seat Base |
| 17. Seat Shell | 23. Integrated Side Impact Protection |
| 18. Rebound Bar | |

2 INSTRUCTION

Thank you for choosing AVOVA Sperber-Fix 61 to ensure your child's safe journey. The seat has been designed, tested and certified according to the UNECE R129, the Enhanced Child Restraint Systems. The seal of approval E (in a circle) and the approval number are located on the orange approval label (a sticker on the child seat). The child seat is designed for a child with statures of 61cm-105cm, approximately from 3 months to 4 years old. It is important that you read this user manual BEFORE installing your child seat. Incorrect installation and/or misuse of the seat could endanger your child. This user manual should be kept in the pocket behind headrest cover so users can refer to it anytime.

The following symbols are used in this user manual:

⚠ DANGER DANGER indicates a hazardous situation which, if not avoided, will result in death or serious injury.

⚠ WARNING WARNING indicates a hazardous situation which, if not avoided, could result in death or serious injury.

⚠ CAUTION CAUTION indicates a hazardous situation which, if not avoided, could result in minor or moderate injury.

GENERAL SAFETY INFORMATION

⚠ DANGER AVOVA Sperber-Fix 61 is approved for statures of 61cm-105cm, in the rearward-facing direction, and 76cm-105cm, in the forward-facing direction.

⚠ DANGER Only use the child seat in rearward-facing direction when your child is less than 76cm in stature. Once your child reaches 76cm, you can use the child seat in either the rearward-facing direction or the forward-facing direction.

⚠ DANGER AVOVA Sperber-Fix 61 can only be used in vehicle seats with ISOFIX Anchoring Points **21**. Please check Vehicle Fitting List for information.

⚠ DANGER The child seat must not be used rearward-facing on a vehicle seat with active airbag. An active airbag will cause serious injury to a child in rearward-facing child seat. The child seat must be installed on a vehicle seat without active airbag or with airbag deactivated.

⚠ DANGER Always use the 5-point harness **2** to secure your child.

⚠ DANGER When the child is taller than 105cm or the child's shoulders exceed the highest position of the shoulder harness belt, the child must change to a seat which is suitable for taller children.

⚠ DANGER Always use the Young Child Insert **14** before your child is 87cm in stature.

⚠ DANGER AVOVA Sperber-Fix 61 has been approved for statures between 61cm and 105cm using ISOFIX Connectors **4** and Support Leg **9** in vehicles.

⚠ DANGER Always use the Support Leg to install the child seat along with ISOFIX Connectors. The Support Leg shall be in contact with the vehicle floor, without Support Leg Indicator **7** showing red.

⚠ DANGER AVOVA Sperber-Fix 61 is compatible with universal seating positions in vehicles. For suitable positions in your vehicle, please read your vehicle handbook.

⚠ DANGER Never leave your child unattended in the child seat.

⚠ WARNING The child seat must always be secured when it is in the vehicle by using ISOFIX anchoring points **21**, even if no child is being transported.

⚠ WARNING The child seat needs to be checked regularly to ensure all the parts are functioning correctly and free from any damages.

⚠ DANGER Please dispose of your seat in the event of any vehicle and/or violent collision as the child seat may be damaged but the damage may not be immediately visible.

⚠ DANGER Do not use lubricants on or modify in any way your Sperber-Fix 61 as this could seriously affect its ability to protect your child.

⚠ WARNING Please do not expose the child seat under intensive direct sunlight. Under intensive direct sunlight, the child seat or some of the child seat parts can get very hot which can cause harm to the child.

⚠ DANGER Use on the rear seat: Move the front seat forward far enough that the child's feet cannot reach the backrest of the front seat as that is safer.

⚠ WARNING The rigid items and plastic parts of a Sperber-Fix 61 shall be so located and installed that they are not liable, during everyday use of the vehicle, to become trapped by a movable seat or in a door of the vehicle.

⚠ CAUTION The vehicle seats may show signs of wear and tear when using child seat. In order to avoid that, car seat protectors may be used.

⚠ DANGER Make sure all passengers are informed about how to release your child in the case of an emergency.

⚠ DANGER Make sure luggage or other objects are properly secured. Unsecured luggage may cause severe injuries to children and adults in case of accidents.

⚠ CAUTION Do not use any aggressive cleaning products, which may harm the construction material of the child seat.

⚠ DANGER AVOVA advises that child seats should not be bought or sold second-hand.

⚠ WARNING DO NOT use at home. It's not designed for home use and can only be used in a vehicle.

⚠ DANGER If in doubt, consult either the child seat manufacturer or the retailer.

3 INSTALLATION GETTING READY

⚠ DANGER Please ensure the vehicle seat that has the child seat installed is in upright position if the vehicle seat is reclinable.

AVOVA Sperber-Fix 61 can be installed rearward-facing or forward-facing by latching the ISOFIX Connectors **4** to the ISOFIX Anchoring Points **21** and attaching the Support Leg **9** to the vehicle floor. It is compatible with universal seating positions in vehicles. Please read your vehicle handbook.

1. Fit the ISOFIX insertion guides **20** to the vehicle's ISOFIX anchoring Points **21** which are located between the surface and backrest of the vehicle seat.

⚠ CAUTION It is suggested to use ISOFIX insertion guides to help in the installation. They help to prevent damages to the vehicle seat. If the vehicle seat can be folded, remove the ISOFIX insertion guides before doing so.

2. Pull the lower part of ISOFIX Release Loop **19** to pull out ISOFIX Connectors **4** from the child seat Base **22**, till ISOFIX Connectors are at the most outward positions.

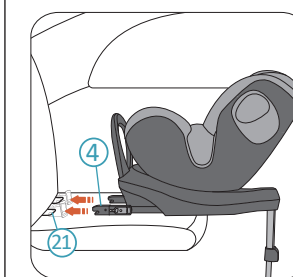

3. Put the child seat on the vehicle seat and aim both ISOFIX Connectors **4** to the ISOFIX Anchoring Points **21** in the vehicle seat.

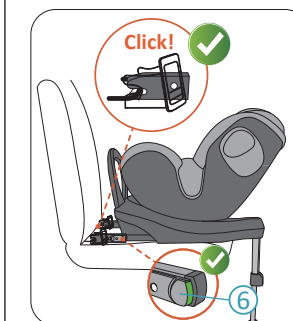

4. Push one ISOFIX Connector to engage it with the ISOFIX Anchoring Point with a click sound. Repeat the action on the other side to engage both ISOFIX Connectors.

⚠ DANGER Check both ISOFIX Indicator Buttons **6**, and if they both show green the ISOFIX Connectors are locked successfully.

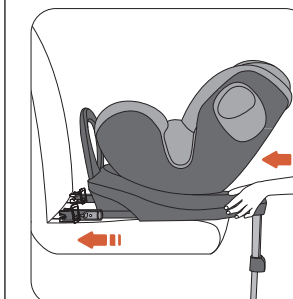

5. Push the child seat firmly towards the vehicle seat backrest as far back as possible until it rests against the vehicle seat backrest.

⚠ DANGER Please check that the child seat is connected securely by trying to pull it out from both sides.

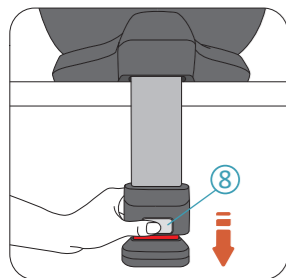

6. Press the Support Leg Release Button (8) to release the Support Leg (9) till it touches the vehicle floor.

⚠ DANGER The Support Leg shall be firmly engaged to the vehicle floor, until the Support Leg Indicator (7) does not show red.

⚠ DANGER The Support Leg must be firmly engaged to the vehicle floor, not free from the vehicle floor or touching other objects. The length of Support Leg shall not raise the child seat upwards from touching the vehicle seat.

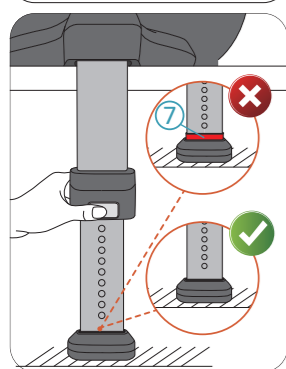

4 CHILD SEAT ROTATION

AVOVA Sperber-Fix 61 has a Seat Shell (17) that can be rotated 360 degrees on the child seat Base (22). When your child is less than 76cm in stature always secure your child in the rearward-facing direction. When your child is between 76cm and 105cm in stature, secure your child in either the rearward-facing direction or forward-facing direction.

⚠ DANGER The child seat can be rotated to facing the sides (like towards the vehicle door) for easy access only, but never transport your child in this way.

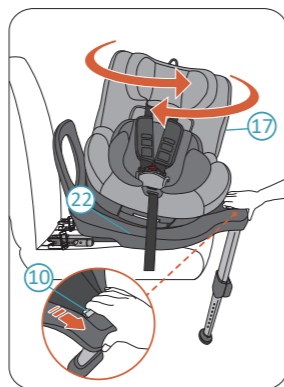

Squeeze the Rotation Release Handle (10) to release the child seat Shell from its locked position. Now you can rotate the child seat Shell. The child seat Shell has 2 locked positions, forward-facing and rearward-facing. When the child seat Shell is moved to a locked position, it will automatically lock with a click sound. The child seat Shell also has two side intermediate stopping positions (unlocked) so that the child can be put in or take out from the seat easily.

⚠ DANGER Try to rotate the child seat shell without release it before each travel to make sure it's locked.

⚠ DANGER Do not travel when the child seat is not locked in either the forward-facing or rearward-facing direction. Side-facing is not allowed for travel.

5 ADJUSTING THE RECLINE

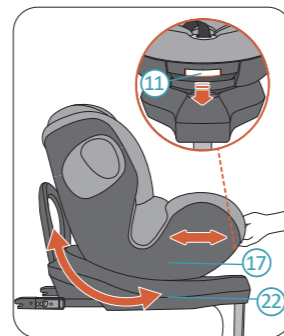

AVOVA Sperber-Fix 61 has 3 recline positions in forward-facing direction and 3 recline positions in rearward-facing direction. To adjust the recline position, squeeze the Recline Adjustment Handle (11) and slide the child seat Shell (17) by pushing and pulling it back and forth against the child seat Base (22).

6 USE OF THE YOUNG CHILD INSERT

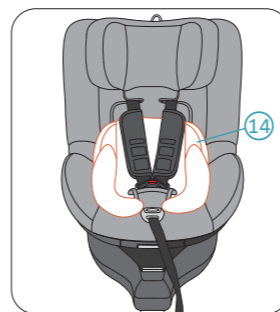

Always use the Young Child Insert (14) when the child stature is below 87cm.

7 POSITIONING THE CHILD

ADJUST HEADREST BEFORE SECURING YOUR CHILD.

⚠ CAUTION Loosen the 5-Point Harness (2) before adjusting the Headrest (1).

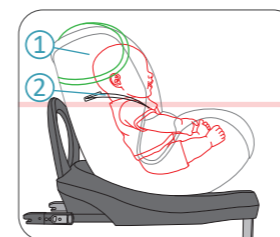

⚠ DANGER When the child seat is used forward-facing, the Headrest shall be adjusted to a level that the shoulder straps of the 5-Point Harness are on the same height or just above the child's shoulders.

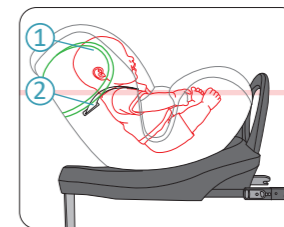

⚠ DANGER When the child seat is used rearward-facing, the Headrest shall be adjusted to a level that the shoulder straps of the 5-Point Harness are on the same height or just below the child's shoulders.

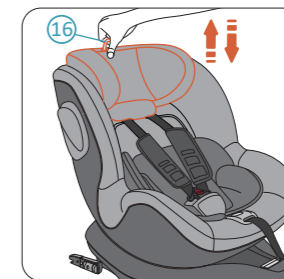

Pull and hold the Headrest Release Ring (16) to release the Headrest (1). Pull the ring up to move the Headrest to higher positions. Hold the ring and push down the Headrest to move the Headrest to lower positions. When the Headrest is at the desired position, release the ring to lock the Headrest.

SECURING YOUR CHILD

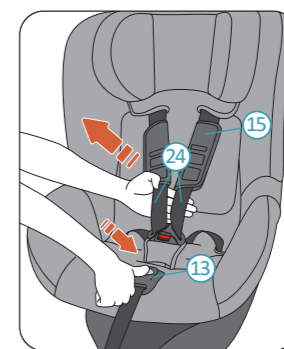

1. Hold down the Harness Adjustment Button (13) and pull shoulder harness (24) towards you as much as possible. Make sure you pull the shoulder harness from beneath the Chest Pads (15) as shown.

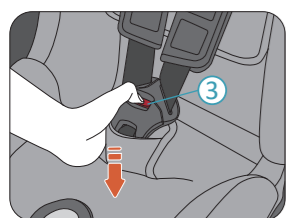

2. Press the red button on the 5-Point Harness Buckle (3) to unbuckle it.

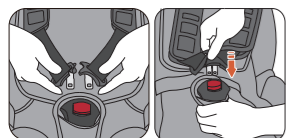

3. Seat your child in Sperber-Fix 61. Route the shoulder harness over your child's shoulders and engage the buckle tongues together. Click the engaged tongues into the buckle body.

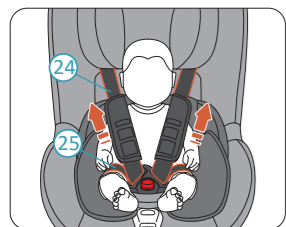

4. Pull both shoulder harness (24) to tighten the lap harness (25).

⚠ DANGER Please check that the Lap harness is worn low down so that the child's pelvis is firmly engaged.

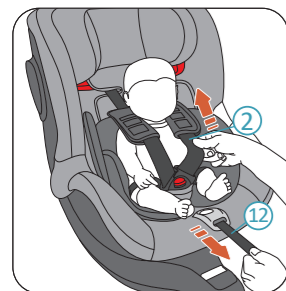

5. Pull the 5-point harness adjuster (12) until the harness (2) firmly secures your child.

⚠ DANGER Please check after tightening that none of the harness straps are twisted.

6. Finally pull both chest pads (15) down fully.

8 REMOVAL

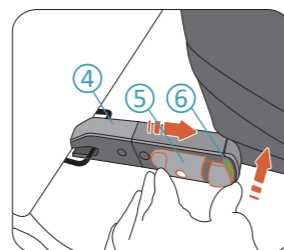

1. Press the ISOFIX Indicator Button (6) and squeeze the ISOFIX Locking Button (5) to release the ISOFIX Connector (4). This action needs to be done to release both ISOFIX connectors. Now you can remove the child seat from your vehicle seat.

2. Store the ISOFIX Connectors by pushing them back into the child seat Base (22).

9 CARE AND MAINTENANCE

CARE AND MAINTENANCE

You may want to remove and wash the cover from time to time. Please do so with mild detergent in the delicates programme of the washing machine (30°C). Please refer to the washing label of the cover. The plastic parts can be cleaned with a mild soap and water.

⚠ DANGER The child seat must not be used without the AVOVA seat cover. The cover is a safety feature and may only be replaced by an original AVOVA cover.

REMOVING AND REFITTING THE SEAT COVER

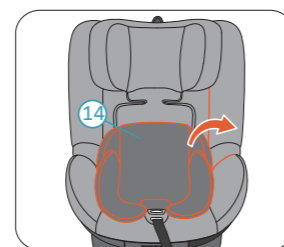

1. Adjust the child seat to forward-facing, child seat Shell (17) at its upright position and Headrest (1) at its highest position.

2. Remove the Young Child Insert (14).

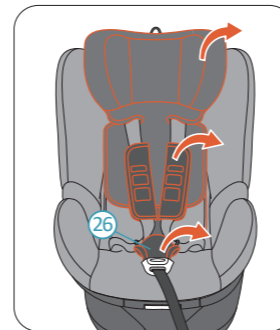

3. Remove the headrest cover.

4. Unbuckle the 5-Point Harness (2). Remove the Chest Pads (15) and the Crotch Pad (26).

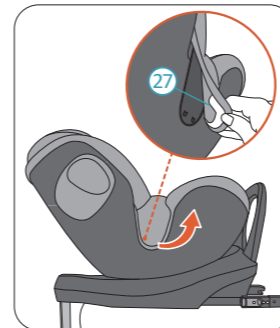

5. Release the cover hooks (27) on both sides. Then remove the child seat shell cover.

Please refit the cover in the reverse order.

10 WARRANTY

1. The warranty for AVOVA Sperber-Fix 61 lasts for 2 years from the date of original purchase from new. The usage of the product should be in accordance with this user manual. Any damage caused by operations against the instructions in this user manual will void the warranty.

2. Please keep your proof of purchase properly in case of a warranty claim.

3. Never use third parties for maintenance, repair or modification otherwise you will void the warranty. Always check with AVOVA retailers for advice.

If you have any further questions regarding the child seat's use, please feel free to contact us:

AVOVA GmbH
Blaubeurer Straße 71
89077 Ulm
Germany

T: +49 731 379941-0
info@avova-childcare.com
www.avova-childcare.com

11 DISPOSAL

When you need to dispose of the child seat, please refer to your local waste disposal regulations. If you have further questions, please contact your communal waste management or administration of your city.