



# Swan-Fix USER MANUAL

- 0-25 kg
- Birth to-7 years
- ≤18 kg
- UNECE regulation no. R44



GB

## 1 PRODUCT OVERVIEW

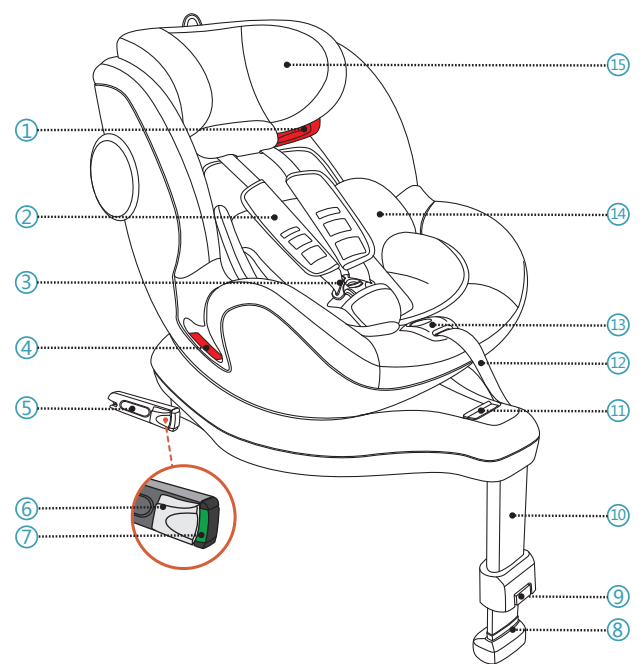

- |                           |                               |
|---------------------------|-------------------------------|
| 1. Shoulder belt guide    | 7. ISOFIX indicator lever     |
| 2. Chest pad              | 8. Support leg indicator      |
| 3. 5-point harness buckle | 9. Support leg release button |
| 4. Lap belt guide         | 10. Support leg               |
| 5. ISOFIX connector       | 11. Rotation release handle   |
| 6. ISOFIX locking button  | 12. 5-point harness adjuster  |

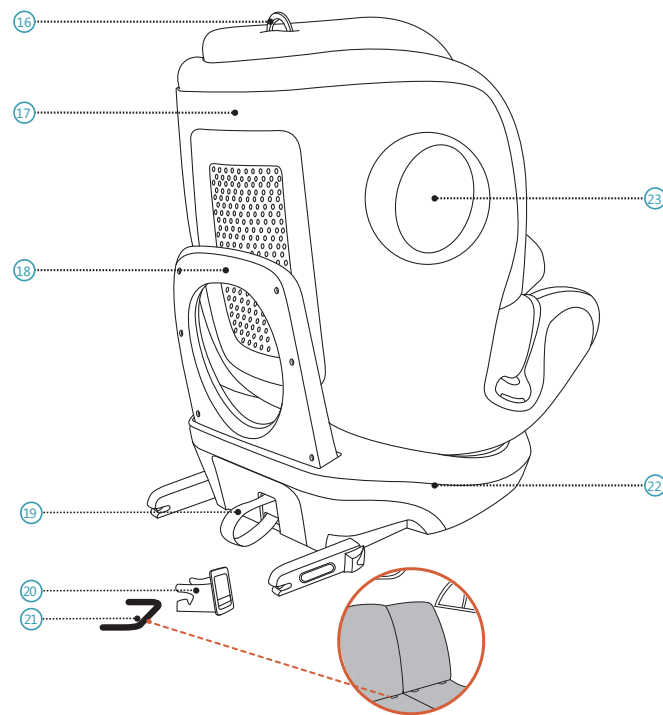

- |                               |  |
|-------------------------------|--|
| 13. Harness adjustment button | 19. ISOFIX release loop                  |
| 14. Newborn insert            | 20. ISOFIX insertion guide               |
| 15. Headrest                  | 21. ISOFIX anchoring points (automobile) |
| 16. Headrest adjustment ring  | 22. Seat Base                            |
| 17. Shell                     | 23. Integrated Side Impact Protection    |
| 18. Rebound bar               |  |

## 2 INSTRUCTION

Thank you for choosing AVOVA Swan-Fix to ensure your child's safe journey. The seat has been designed, tested and certified according to the UNECE R44, the Child Restraint Systems.

The seal of approval E (in a circle) and the approval number are located on the orange approval label (a sticker on the child seat). The child seat is designed for a child with weight of 0-25 kg, approximately from birth to 7 years old. It is important that you read this user manual BEFORE installing your child seat. Incorrect installation and/or misuse of the seat could endanger your child. This user manual should be kept in the pocket behind headrest cover so users can refer to it anytime.

The following symbols are used in this user manual:

**DANGER** DANGER indicates a hazardous situation which, if not avoided, will result in death or serious injury.

**WARNING** WARNING indicates a hazardous situation which, if not avoided, could result in death or serious injury.

**CAUTION** CAUTION indicates a hazardous situation which, if not avoided, could result in minor or moderate injury.

### GENERAL SAFETY INFORMATION

**DANGER** AVOVA Swan-Fix is approved for child weight 0-18 kg in the rearward-facing direction, and 9-25 kg in the forward-facing direction.

**DANGER** Only use the child seat in the rearward-facing direction when your child is less than 9 kg in weight. Once your child reaches 9 kg, you can use the child seat in either the rearward-facing direction or the forward-facing direction. Once your child reaches 18 kg, you must use the child seat in forward facing direction.

**DANGER** For children below 18 kg in weight, Swan-Fix can only be installed on vehicle seats with ISOFIX Anchoring Points 21. Please check Vehicle Type List for information.

**DANGER** The child seat must not be used rearward-facing on a vehicle seat with active airbag. An active airbag will cause serious injury to a child in rearward-facing child seat. The child seat must be installed on a vehicle seat without active airbag or with airbag deactivated.

**DANGER** When the child is heavier than 25 kg or the child's shoulders exceed the highest position of the shoulder belt guide 1, the child must change to a seat which is suitable for larger children.

**DANGER** Only use the 5-point harness to secure your child when he/she is less than 15 kg in weight. Once your child reaches 18 kg and over, you must use the vehicle's 3-point belt.

**DANGER** Always use the Newborn Insert 14 before your child is 13 kg in weight.

**DANGER** Do not use any load bearing contact points other than those described in this user manual and marked on the child seat.

**DANGER** Always use the Support Leg 10 to install the child seat along with ISOFIX Connectors 5 before the child reaches 15 kg. The Support Leg shall be in contact with the vehicle floor, without Support Leg Indicator 8 showing red.

**DANGER** AVOVA Swan-Fix is a universal child seat with installation on vehicles by 3-point safety belt for children between 15 and 25 kg, and is compatible with most but not all vehicle seats. For suitable positions in your vehicle, please read your vehicle handbook.

**DANGER** AVOVA Swan-Fix is a semi-universal child seat for children from birth to 25 kg. Installation uses ISOFIX and Support Leg from birth to 18 kg, or uses ISOFIX and 3-point belt from 15 to 25 kg. For suitable positions in your vehicle, refer to the Vehicle Fitting List and your vehicle handbook.

**DANGER** Never leave your child unattended in the child seat.

**WARNING** The child seat must always be secured when it is in the vehicle, even if no child is being transported, by using ISOFIX anchoring points 21 or 3-point belt when being used without ISOFIX.

**WARNING** The child seat needs to be checked regularly to ensure all the parts are functioning correctly and free from any damages.

**DANGER** Please dispose of your child seat in the event of any vehicle and/or violent collision as the child seat may be damaged but the damage may not be immediately visible.

**DANGER** Do not use lubricants on or modify in any way your AVOVA Swan-Fix as this could seriously affect its ability to protect your child.

**WARNING** Please do not expose the child seat under intensive direct sunlight. Under intensive direct sunlight, the child seat or some of the child seat parts can get very hot which can cause harm to the child.

**DANGER** Use on the rear seat: Move the front seat forward far enough that the child's feet cannot reach the backrest of the front seat as that is safer.

**WARNING** The rigid items and plastic parts of a Swan-Fix shall be so located and installed that they are not liable, during everyday use of the vehicle, to become trapped by a movable seat or in a door of the vehicle.

**CAUTION** The vehicle seats may show signs of wear and tear when using child seats. In order to avoid that, car seat protectors may be used.

**DANGER** Make sure all passengers are informed about how to release your child in the case of an emergency.

**DANGER** Make sure luggage or other objects are properly secured. Unsecured luggage may cause severe injuries to children and adults in case of accidents.

**CAUTION** Do not use any aggressive cleaning products, which may harm the construction material of the child seat.

**DANGER** AVOVA advises that child seats should not be bought or sold second-hand.

**WARNING** DO NOT use at home. It's not designed for home use and can only be used in a vehicle.

**DANGER** If in doubt, consult either the child seat manufacturer or the retailer.

## 3 INSTALLATION GETTING READY

**DANGER** Please ensure the vehicle seat on which the child seat is installed is in the upright position if the vehicle seat is reclinable.

**A. INSTALLING WITH ISOFIX AND SUPPORT LEG**  
AVOVA Swan-Fix can be installed rearward-facing or forward-facing by latching the ISOFIX Connectors to the ISOFIX Anchoring Points 21 and attaching the Support Leg 10 to the vehicle floor. It is approved as a semi-universal child seat for children with weights of 0-18 kg and may not fit all vehicle seats. Please read the Vehicle Type List and your vehicle handbook.

1. Fit the ISOFIX insertion guides 20 to the vehicle's ISOFIX Anchoring Points 21 which are located between the surface and backrest of the vehicle seat.

**CAUTION** It is suggested to use ISOFIX insertion guides 20 to facilitate the installation. They help to prevent damages to the vehicle seat. If the vehicle seat can be folded, remove the ISOFIX insertion guides before doing so.

2. Pull the lower part of ISOFIX Release Loop 19 to shoot out ISOFIX Connectors 5 from the child seat base, till both ISOFIX Connectors are at the most outward positions.



3. Put the child seat on the vehicle seat and aim both ISOFIX Connectors 5 to the ISOFIX Anchoring Points 21 in the vehicle seat.



4. Push one ISOFIX Connector 5 to engage it with the ISOFIX Anchoring Point 21 with a click sound. Repeat the action on the other side to engage both ISOFIX Connectors.

**DANGER** Check both ISOFIX indicator levers 7, and if they both show green the ISOFIX Connectors are locked correctly.

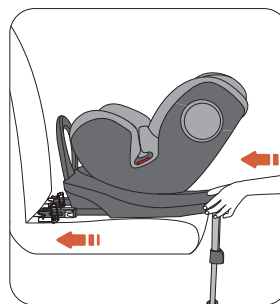

5. Push the child seat firmly towards the vehicle seat backrest as far back as possible until it rests against the vehicle seat backrest.

**DANGER** Please check that the child seat is connected securely by trying to pull it out from both sides.

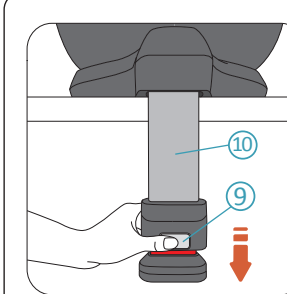

6. Push the Support Leg Release Button 9 to release the Support Leg 10 till it touches the vehicle floor.

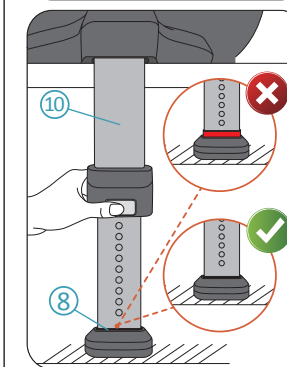

**DANGER** The Support Leg 10 shall be firmly engaged to the vehicle floor, until the Support Leg Indicator 8 does not show red.

**DANGER** The Support Leg must be firmly engaged to the vehicle floor, not free from the vehicle floor or touching other objects. The length of Support Leg shall not raise the child seat upwards from touching the vehicle seat.

### B. INSTALLING WITH 3-POINT BELT

Swan-Fix can be installed forward-facing with a vehicle's 3-point belt, approved to UNECE Regulation No.16 or other. In this mode the seat can transport children with weights 15-25 kg. It is compatible with universal seating positions in vehicles. Please read your vehicle handbook.

**WARNING** Please adjust the support leg 10 to its shortest position so it will not interfere with the installation.

**WARNING** Please ensure the ISOFIX connectors 5 are fully stowed inside the seat in their fully retracted stowed position.

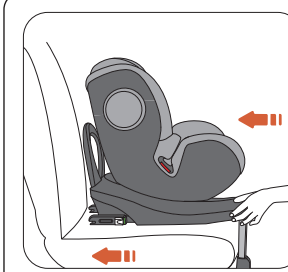

1. Position the Swan-Fix child seat on the vehicle seat. Push the child seat towards the vehicle seat until it rests against the vehicle seat backrest.

2. Carry out the steps in "Positioning the child" Part B.

### C. INSTALLING WITH 3-POINT BELT ALONG WITH ISOFIX

Swan-Fix can be installed forward-facing with a vehicle's 3-point belt, approved to UNECE Regulation No.16 or other. It can be attached to the vehicle seat by ISOFIX in addition. It is approved as a semi-universal child seat for children with weights of 15-25 kg and may not fit all vehicle seats. Please read the Vehicle Type List and your vehicle handbook.

**WARNING** Please adjust the support leg 10 to its shortest position so it will not interfere with the installation.

1. Carry out step 1 to step 5 in "Installation" section Part A INSTALLING WITH ISOFIX AND SUPPORT LEG. Do not carry out step 6 which engages the support leg.

2. Carry out the steps in "Positioning the child" section Part B.

## 4 CHILD SEAT ROTATION

AVOVA Swan-Fix has a Seat Shell that can be rotated 360 degrees on the child seat Base. When your child is less than 9 kg in weight always secure he/she in the rearward-facing direction. When your child is between 9 kg and 18 kg in weight, secure he/she in either the rearward-facing direction or forward-facing direction. When your child is over 18 kg in weight, secure he/she in the forward facing direction. The child seat can be rotated to facing the sides (like towards the vehicle door) for easy access only. But NEVER transport your child in this way.

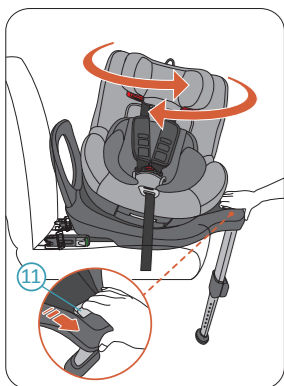

Squeeze the Rotation Release Handle (11) to release the child seat Shell from its locked position. Now you can rotate the child seat Shell. The child seat Shell has 2 locked positions, forward-facing and rearward-facing. When the child seat Shell is moved to a locked position, it will automatically lock with a click sound. The child seat Shell also has two side intermediate stopping positions (unlocked) so that the child can be put in or taken out from the seat easily.

**⚠ DANGER** Try to rotate the child seat shell without releasing it before each travel to make sure it's locked.

**⚠ DANGER** Do not travel when the child seat is not locked in either the forward-facing or rearward-facing direction. Side-facing is not locked and is not suitable for travel.

## 5 ADJUSTING THE RECLINE

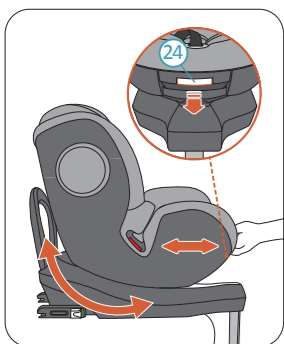

AVOVA Swan-Fix has 3 recline positions in forward-facing direction and 3 recline positions in rearward-facing direction. To adjust the recline position, squeeze the Recline Adjustment Handle (24) and slide the child seat Shell by pushing and pulling it back and forth against the child seat Base.

**⚠ DANGER** Only use the upright position in forward-facing direction when securing your child with the vehicle 3-point belt.

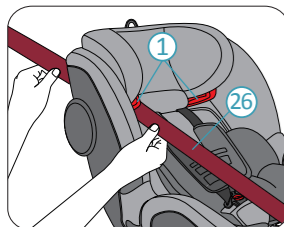

4. Route the shoulder belt (26) into the red shoulder belt guide (1) of the headrest until it lies completely in the shoulder belt guide and the shoulder belt section is not twisted.

**⚠ WARNING** If the shoulder belt guide is concealed by the seat shell, adjust the headrest upwards to allow the shoulder belt section can be inserted easily into the shoulder belt guide and then adjust the headrest back to the correct height.



**⚠ DANGER** Check that the shoulder belt (26) runs over your child's collar-bone, not across his/her neck.



5. First pull the shoulder belt part that crosses the body of the child to remove the slack from lap section. Then pull the shoulder belt part above the child seat to remove the remaining slack.

**⚠ DANGER** AFTER SECURING YOUR CHILD, PLEASE CHECK BELOW BEFORE YOUR TRAVEL:

1. The child seat is correctly secured. The lap belt runs in the lap belt guide on both sides of the seat shell.
2. The shoulder belt runs in the lap belt guide on the side of vehicle's 3-point belt buckle and the shoulder belt guide on the other side of the headrest.
3. The vehicle's 3-point belt is tight and not twisted. The 3-point belt buckle must not be positioned in the lap belt guide.

## 6 USE OF NEWBORN INSERT

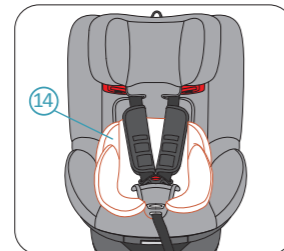

Always use the Newborn Insert (14) when the child weight is below 13 kg.

## 7 POSITIONING THE CHILD

### A. SECURING YOUR CHILD WITH 5-POINT HARNESS

#### ADJUST HEADREST BEFORE SECURING YOUR CHILD

**⚠ CAUTION** Loosen the 5-Point Harness before adjusting the Headrest.

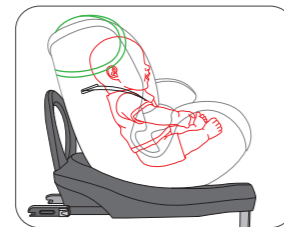

1. Seat your child in the child seat.

**⚠ DANGER** When the child seat is used forward-facing, the Headrest shall be adjusted to a level that the shoulder straps of the 5-Point Harness are on the same height or just above the child's shoulders.

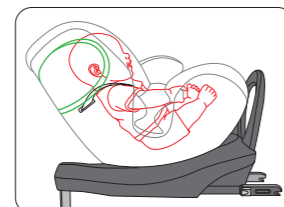

**⚠ DANGER** When the child seat is used rearward-facing, the Headrest shall be adjusted to a level that the shoulder straps of the 5-Point Harness are on the same height or just below the child's shoulders.

## 8 REMOVAL AND REFITTING THE 5-POINT HARNESS

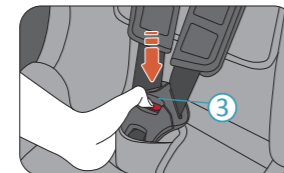

1. Rotate the child seat to the forward-facing direction.

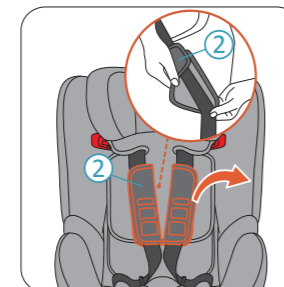

2. Press the red button on the harness buckle (3) and open the harness.

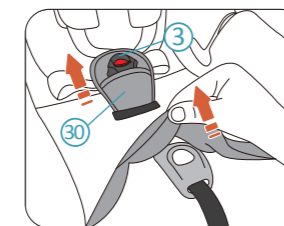

3. Open the chest Pad (2). Detach the chest pad from the strap.

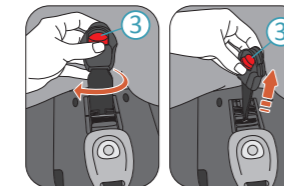

4. Pull out and remove the crotch pad (30). Insert the 5-point harness buckle (3) through the hole in the cover.

5. Remove the 5-point harness buckle (3) along with the crotch strap out from the H shaped hole in the child seat shell.

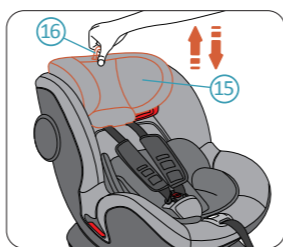

2. Pull and hold the Headrest Adjustment Ring (16) to release the headrest. Pull the ring up to move the Headrest (15) to higher positions. Hold the ring and push down the Headrest to move the Headrest to lower positions. When the Headrest is at the desired position, release the ring to lock the Headrest.

### SECURING YOUR CHILD

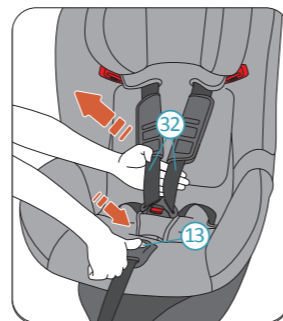

1. Hold down the Harness Adjustment Button (13) and pull shoulder harness towards you as much as possible. Make sure you pull the shoulder harness from beneath the Chest Pads (32) as shown.

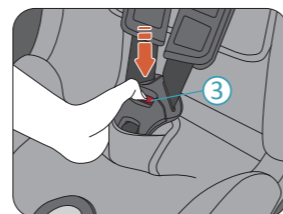

2. Press the red button on the 5-Point Harness Buckle (3) to unbuckle it.

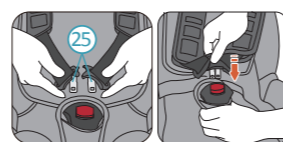

3. Seat your child in Swan-Fix. Route the shoulder harness over your child's shoulders and engage the buckle tongues (25) together. Click the engaged tongues into the buckle body. When the buckle is locked, the green sign will display.

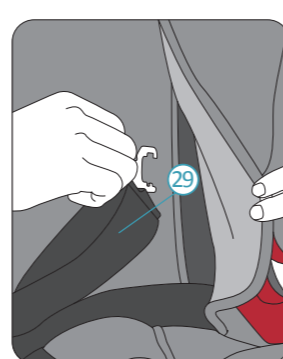

6. Hide the shoulder straps (29) behind seat shell cover on the sides. And hide the Chest Pad straps behind Headrest cover.

Please refit the 5-point harness in the reverse order.

## 9 REMOVAL WITH ISOFIX

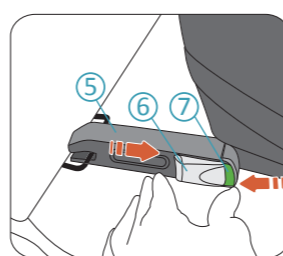

1. Press the ISOFIX Indicator Lever (7) at the lower end and push the ISOFIX Locking Button (6) to release the ISOFIX Connector (5). This action needs to be done to release both ISOFIX connectors. Now you can remove the child seat from your vehicle seat.

2. Store the ISOFIX Connectors by pushing them back into the child seat Base.

## 10 CARE AND MAINTENANCE

You may want to remove and wash the cover from time to time. Please do so with mild detergent in the delicates programme of the washing machine (30°C). Please refer to the washing label of the cover. The plastic parts can be cleaned with a mild soap and water.



4. Pull both shoulder harness straps to tighten the lap harness.

**⚠ DANGER** Please check that the lap strap is worn low down so that the child's pelvis is firmly engaged.



5. Pull the 5-point harness adjuster (12) until the harness firmly secures your child.

**⚠ DANGER** Please check after tightening that none of the harness straps are twisted.

6. Finally pull both chest pads down fully.

### B. SECURING YOUR CHILD WITH 3-POINT SEAT BELT

#### ADJUST HEADREST BEFORE SECURING YOUR CHILD.

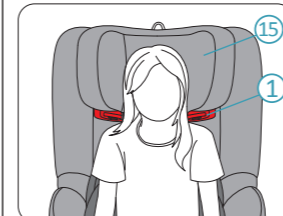

1. Seat your child in the child seat.

2. The headrest (15) shall be adjusted to a level that the shoulder belt guide (1) is just above the child's shoulders.

**⚠ CAUTION** Made sure that the Chest Pads, Crotch Pad, 5-point Harness Buckle and crotch strap are removed, according to the instructions in Section 8.



1. Position the vehicle's 3-point belt in front of the child and lock the belt into the buckle of the vehicle with a click. Make sure that the 3-point belt is not twisted.

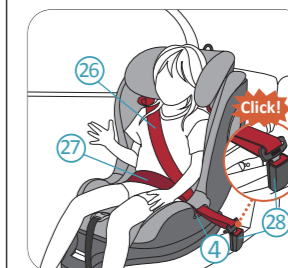

2. Place the shoulder belt section (26) and lap belt section (27) on the side of the vehicle seatbelt buckle (28) into the lap belt guide (4) of the seat shell.

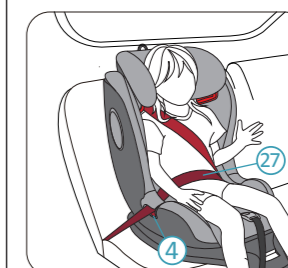

3. Place the lap belt section (27) on the other side of the seat shell into the lap belt guide (4).

**⚠ DANGER** The lap belt section must lie as low as possible over the child's pelvis on both sides to provide the best protection.

## 11 WARRANTY

1. The warranty for AVOVA Swan-Fix lasts for 2 years from the date of original purchase from new. The usage of the product should be in accordance with this user manual. Any damage caused by operations against the instructions in this user manual will void the warranty.
2. Please keep your proof of purchase properly in case of a warranty claim.
3. Never use third parties for maintenance, repair or modification otherwise you will void the warranty. Always check with AVOVA retailers for advice.

If you have any further questions regarding the child seat's use, please feel free to contact us:  
AVOVA GmbH  
Blaubeurer Straße 71  
89077 Ulm  
Germany

T:+49 731 379941-0  
info@avova-childcare.com  
www.avova-childcare.com

## 12 DISPOSAL

When you need to dispose of the child seat, please refer to your local waste disposal regulations. If you have further questions, please contact your communal waste management or administration of your city.

**⚠ DANGER** The child seat must not be used without the AVOVA seat cover. The cover is a safety feature and may only be replaced by an original AVOVA cover.

#### REMOVING AND REFITTING THE SEAT COVER

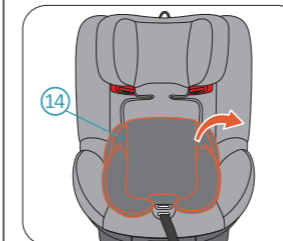

1. Adjust the child seat to forward-facing, child seat Shell at its upright position and Headrest to its highest position.

2. Remove the newborn insert (14).

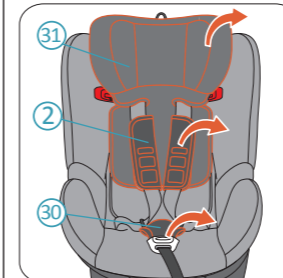

3. Remove the headrest cover (31).

4. Unbuckle the 5-Point Harness. Remove the Chest Pad (2) and the Crotch Pad (30).



5. Remove the child seat shell cover.

Please refit the cover in the reverse order.